

# SISTEMA DI CANALIZZAZIONE PER EVACUAZIONE FUMI

## Tubazioni in PVC

Codice	Modello	Iva Esclusa	Iva Inclusa
4043001	COMPAIRflow 150 system	€ 40,00	€ 48,80

Tubo a sezione rettangolare in PVC lungo 1000 mm



4043005	COMPAIRflow 150 system	€ 13,00	€ 15,86
---------	------------------------	---------	---------

Connettore in PVC per tubi rettangolari

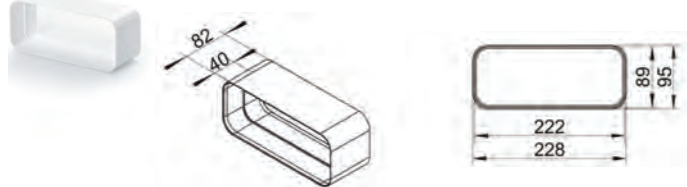

4043007	COMPAIRflow 150 system	€ 19,00	€ 23,18
---------	------------------------	---------	---------

Connettore orizzontale in PVC a 15°

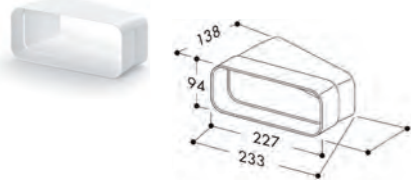

4043003	COMPAIRflow 150 system	€ 42,00	€ 51,24
---------	------------------------	---------	---------

Curva orizzontale in PVC a sezione rettangolare



4043004	COMPAIRflow 150 system	€ 31,00	€ 37,82
---------	------------------------	---------	---------

Curva verticale in PVC a sezione rettangolare



Codice	Modello	Iva Esclusa	Iva Inclusa
4043002	COMPAIRflow 150 system	€ 44,00	€ 53,68

Curva in PVC da sezione rettangolare a sezione tonda

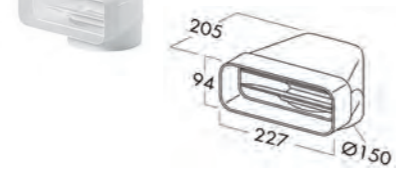

4043006	COMPAIRflow 150 system	€ 24,00	€ 29,28
---------	------------------------	---------	---------

Raccordo in PVC da sezione rettangolare a sezione circolare

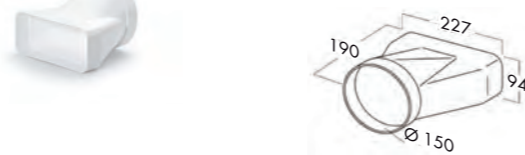

4043074	COMPAIRflow 150 system	€ 130,00	€ 158,60
---------	------------------------	----------	----------

Curva in PVC a sezione rettangolare da verticale a orizzontale

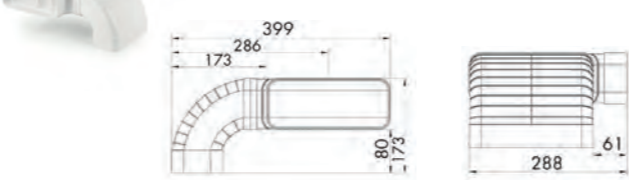

4043042	COMPAIRflow 150 system	€ 52,00	€ 63,44
---------	------------------------	---------	---------

Raccordo flessibile in PVC a sezione rettangolare

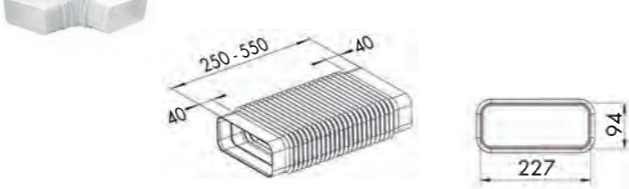

4043043	COMPAIRflow 150 system	€ 55,00	€ 67,10
---------	------------------------	---------	---------

Raccordo flessibile in PVC da sezione rettangolare a sezione circolare

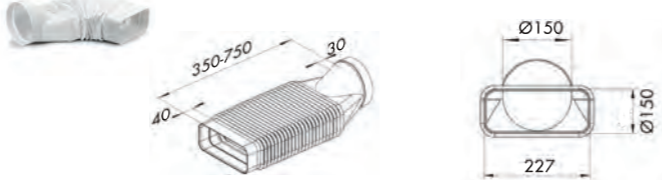

## Tubazioni in PVC

Codice	Modello	Iva Esclusa	Iva Inclusa
4052102	COMPAIRflow 150 system	€ 46,00	€ 56,12

Tubo in PVC a sezione circolare lungo 1000 mm

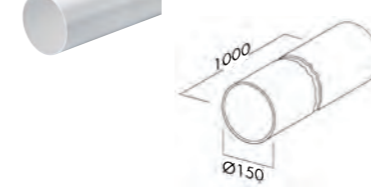

4052017	COMPAIRflow 150 system	€ 13,00	€ 15,86
---------	------------------------	---------	---------

Connettore in PVC per tubi tondi

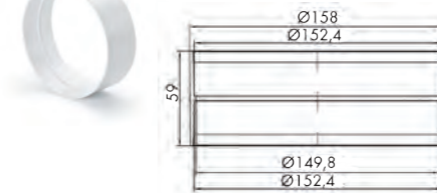

4052015	COMPAIRflow 150 system	€ 37,00	€ 45,14
---------	------------------------	---------	---------

Curva a sezione circolare in PVC

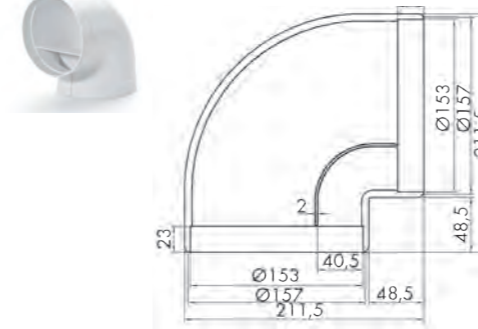

## Tubazioni in acciaio galvanizzato

Codice	Modello	Iva Esclusa	Iva Inclusa
4061003	COMPAIRsteel 150 system	€ 147,00	€ 179,34

Tubo a sezione rettangolare in acciaio galvanizzato con guarnizioni integrate lungo 1000 mm

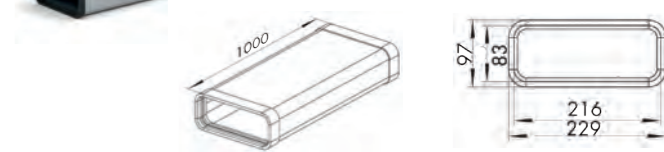

4061029	COMPAIRsteel 150 system	€ 50,00	€ 61,00
---------	-------------------------	---------	---------

Supporto per canali piatti in acciaio galvanizzato inseriti nel massetto L 30 cm (per tubo lungo 1000 mm usarne 2 pezzi); con questo supporto le tubazioni sostengono fino a 100 kg di peso.

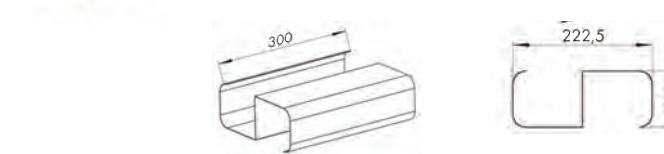

4061027	COMPAIRsteel 150 system	€ 30,00	€ 36,60
---------	-------------------------	---------	---------

Guarnizione punto congiunzione tubi piatti in acciaio galvanizzato

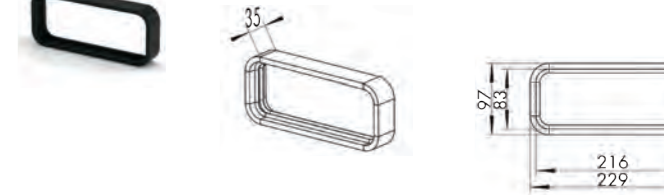

4061017	COMPAIRsteel 150 system	€ 64,00	€ 78,08
---------	-------------------------	---------	---------

Connettore per tubi rettangolari in acciaio galvanizzato

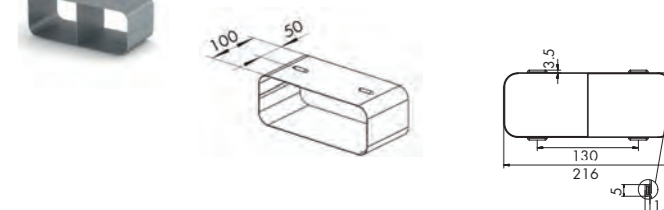

4061002	COMPAIRsteel 150 system	€ 160,00	€ 195,20
---------	-------------------------	----------	----------

Tubo a sezione rettangolare flex alluminio con guarnizioni integrate lungo 1000 mm



**Tubazioni in acciaio galvanizzato**

Codice	Modello	Iva Esclusa	Iva Inclusa
4061014	COMPAIRsteel 150 system	€ 77,00	€ 93,94

Curva orizzontale in acciaio galvanizzato a sezione rettangolare

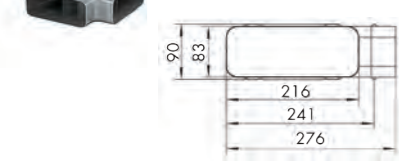

4061034	COMPAIRsteel 150 system	€ 96,00	€ 117,12
---------	-------------------------	---------	----------

Connettore per curve in acciaio galvanizzato con guarnizioni integrate



4061013	COMPAIRsteel 150 system	€ 71,00	€ 86,62
---------	-------------------------	---------	---------

Curva verticale in acciaio galvanizzato a sezione rettangolare

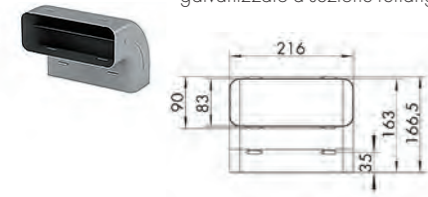

4061012	COMPAIRsteel 150 system	€ 81,00	€ 98,82
---------	-------------------------	---------	---------

Curva in acciaio galvanizzato da sezione rettangolare a sezione tonda



4061011	COMPAIRsteel 150 system	€ 77,00	€ 93,94
---------	-------------------------	---------	---------

Raccordo da sezione rettangolare a sezione circolare in acciaio galvanizzato



Codice	Modello	Iva Esclusa	Iva Inclusa
4061028		€ 140,00	€ 170,80

Curva da sezione rettangolare a sezione circolare in acciaio galvanizzato



4061024	COMPAIRsteel 150 system	€ 160,00	€ 195,20
---------	-------------------------	----------	----------

Curva da verticale a orizzontale in acciaio galvanizzato a sezione rettangolare



4061020	COMPAIRsteel 150 system	€ 55,00	€ 67,10
---------	-------------------------	---------	---------

Elemento tondo di connessione a muro per tubi tondi in acciaio galvanizzato

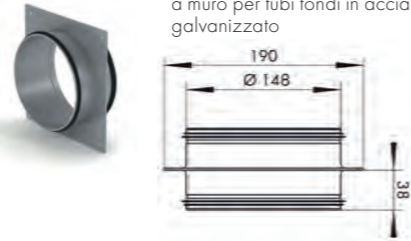

4061022		€ 35,00	€ 42,70
---------	--	---------	---------

Gancio fissaggio soffitto tubi piatti in acciaio galvanizzato o PVC



4061023		€ 20,00	€ 24,40
---------	--	---------	---------

Gancio fissaggio soffitto tubi tondi in acciaio galvanizzato o PVC



Codice	Modello	Iva Esclusa	Iva Inclusa
4043018	Compair Flow 125/150	€ 30,00	€ 36,60

Contenitore raccogli condensa per tubi a sezione circolare diametro 150 mm



**Terminali in acciaio a muro con flap interno**

Codice	Modello	Iva Esclusa	Iva Inclusa
4022038	COMPAIRflow 150 system	€ 249,00	€ 303,78

Terminale a muro in acciaio a sezione rettangolare orizzontale con flap interno



4022012	COMPAIRflow 150 system	€ 211,00	€ 257,42
---------	------------------------	----------	----------

Terminale a muro in acciaio a sezione tonda con flap interno



4022029	COMPAIRflow 150 system	€ 273,00	€ 333,06
---------	------------------------	----------	----------

Terminale a muro in acciaio a sezione rettangolare verticale con flap interno

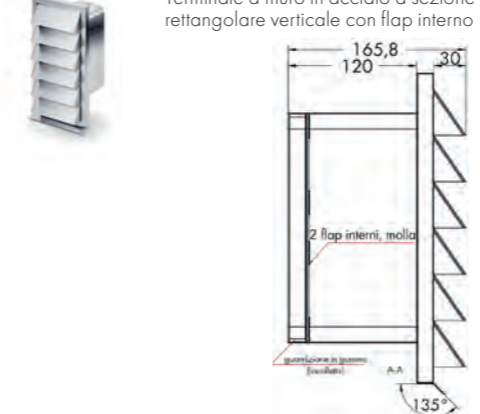

Codice	Modello	Iva Esclusa	Iva Inclusa
4061039		€ 12,00	€ 15,86

Nastro alluminio per tubazioni altezza 50 mm - lunghezza 10 mt



4021128		€ 11,00	€ 13,42
---------	--	---------	---------

Nastro bianco in PVC per tubazioni altezza 50 mm - lunghezza 10 mt



Codice	Modello
4022038	COMPAIRflow 150 system

Disegni: vista dall'alto e vista frontale



4022012	COMPAIRflow 150 system
---------	------------------------

Disegni: vista dall'alto e vista frontale

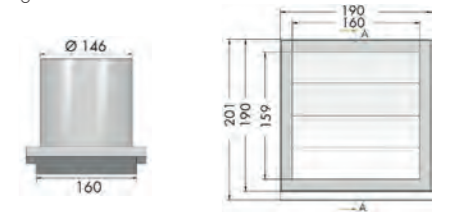

4022029	COMPAIRflow 150 system
---------	------------------------

Disegni: vista dall'alto e vista frontale

